



Direct-Drive Linear Actuator
直顶电动推杆

技术参数

驱动形式:单电机驱动
 负载形式:推/拉
 防护等级:IP44
 行程开关:内置
 环境温度: -25°C-40°C
 相对湿度 :20% - 80%
 海拔高度:不超过1000M
 操作模式:2分钟开,18分钟关

Technical data

Drive type:Single motor drive
 Type of load:Push/Pull
 Protection category:IP44
 Limit switch:Built-in
 Ambient temperature :-25°C-40°C
 Air relative humidity:20% - 80%
 Attitude height:Within 1000M
 Duty cycle:2 min. on/18 min. off

型号 Model	最大推力 Max. Push force (N)	最大拉力 Max. Pull force (N)	速度 Speed (mm/s)		标准行程 Stroke (mm)
			空载 No load	负载 On load	
Z05-01	6000	4000	6	4	150/200/300
Z05-02	4000	3000	12	8.5	150/200/300
Z05-03	2000	2000	18	13	150/200/300
Z05-04	1000	1000	36	27	150/200/300
Z05-05	750	750	48	36	150/200/300

外形图 Outline Drawing

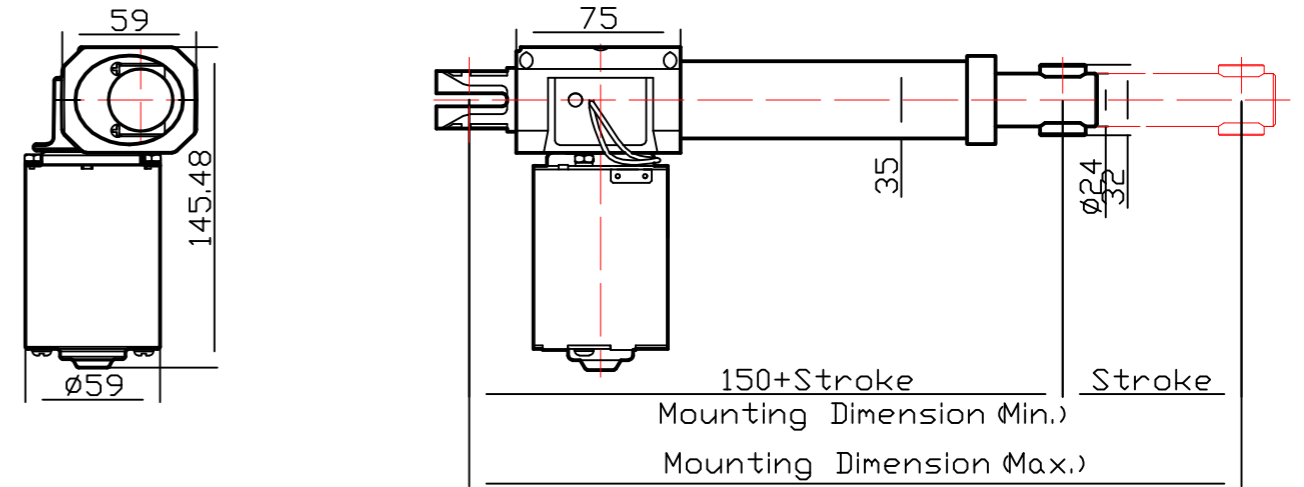

性能图 Performance Curve

